

Highfield Boats

Rollbar Installation Guide

(SP520-560)

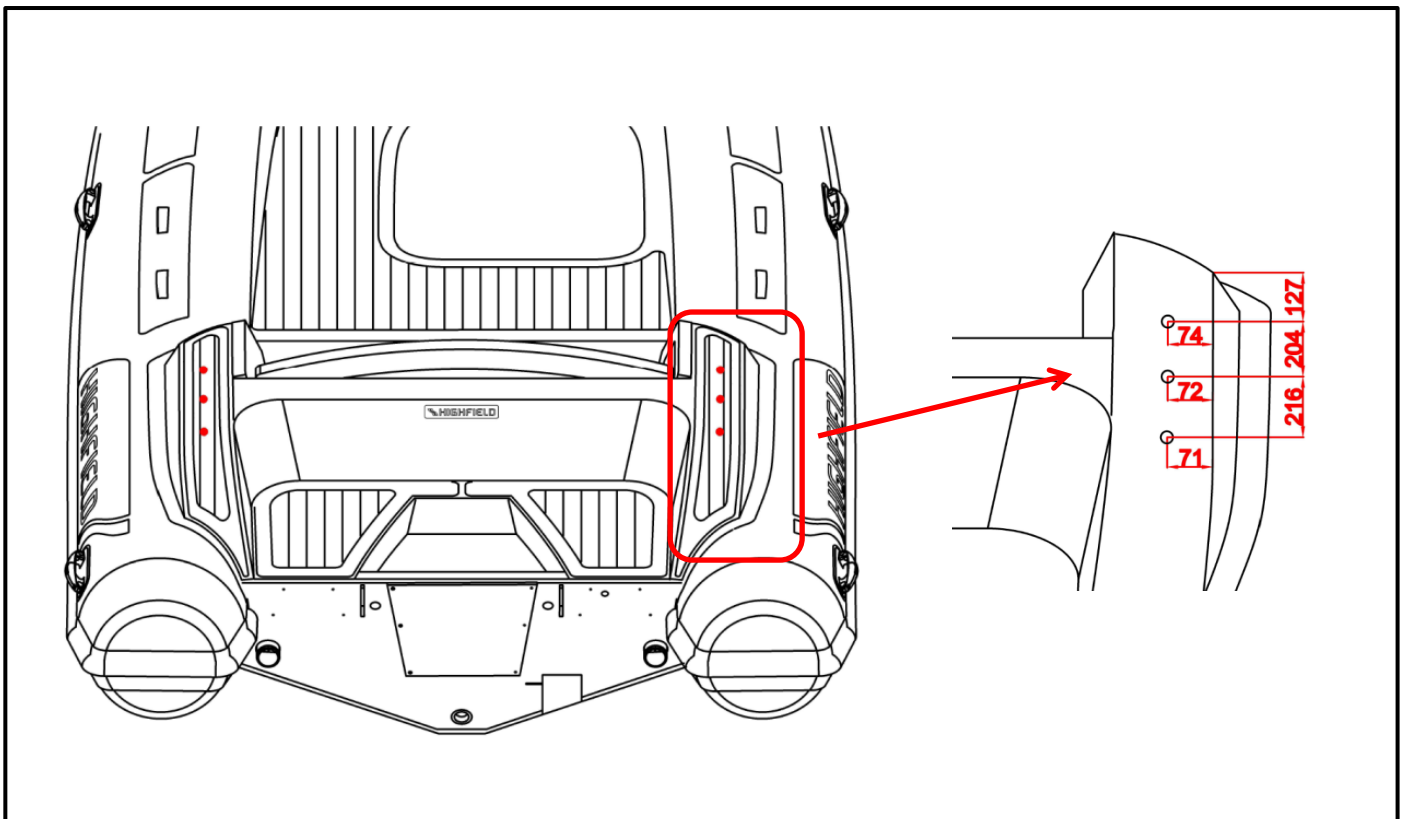

① Locate the holes using the drawing.

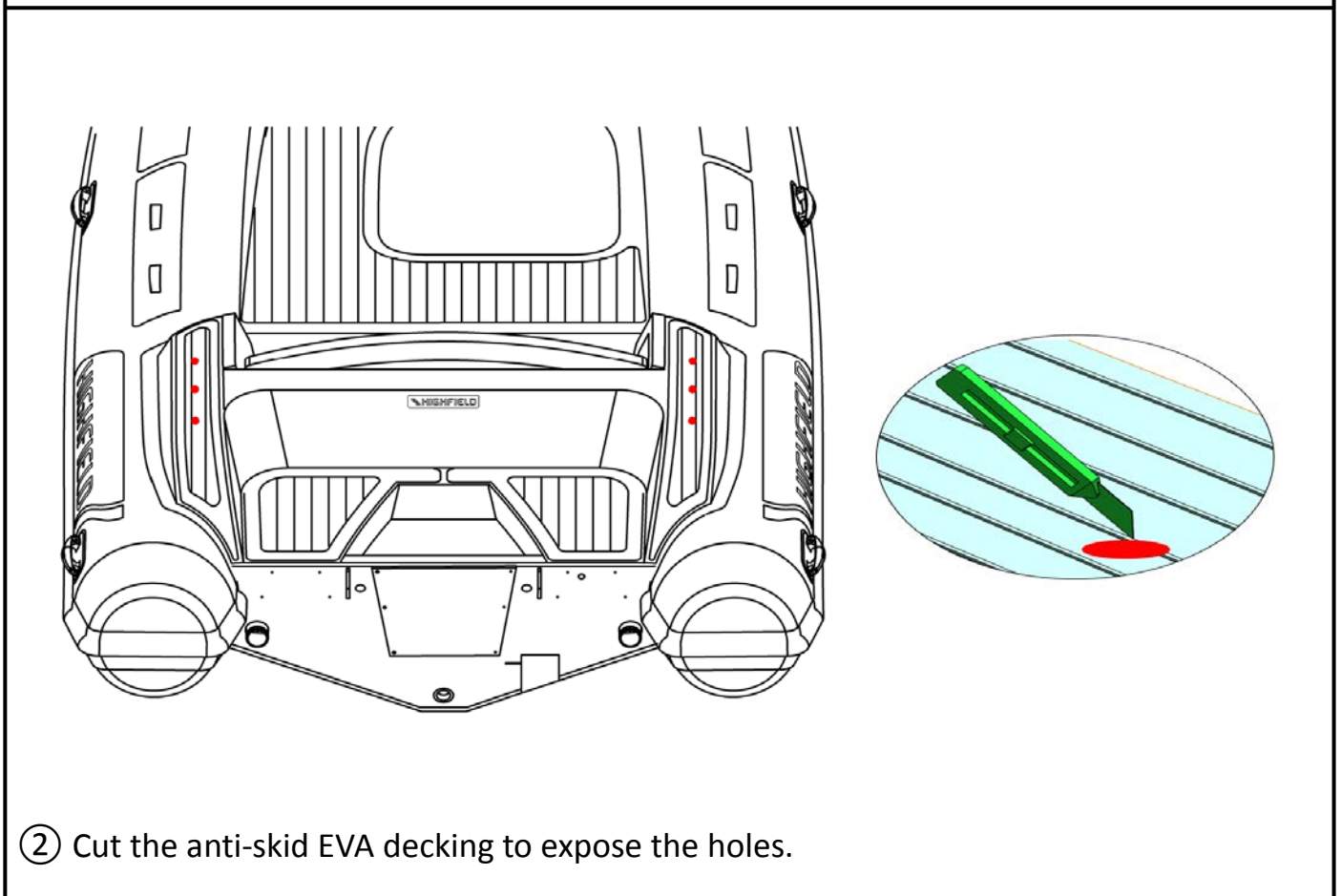

② Cut the anti-skid EVA decking to expose the holes.

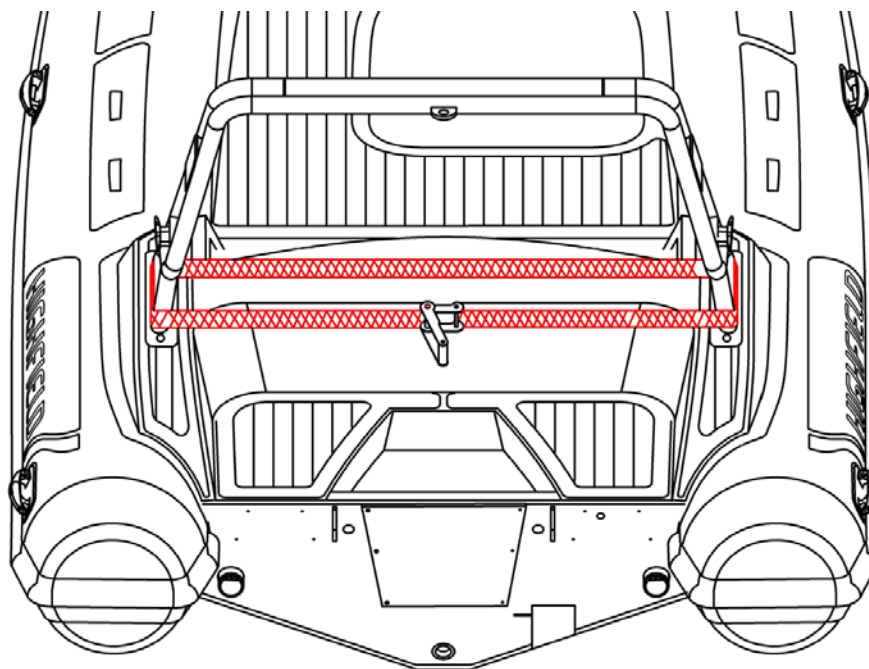

③ Use a ratchet strap to adjust the width of the rollbar.

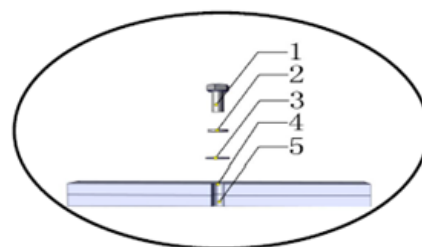
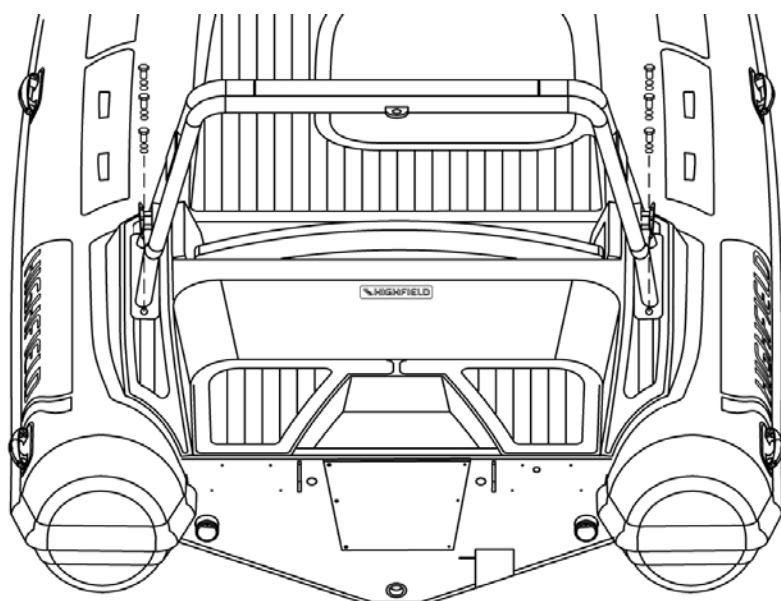

- 1—Screw M8×40mm;
- 2—Stainless steel flat washer M8
- 3—Plastic washer M8
- 4—Rollbar base;
- 5—Stern plate

④ Use insulating compound on the M8 stainless steel screws supplied with the rollbar. Fasten the rollbar to the transom using the screws.

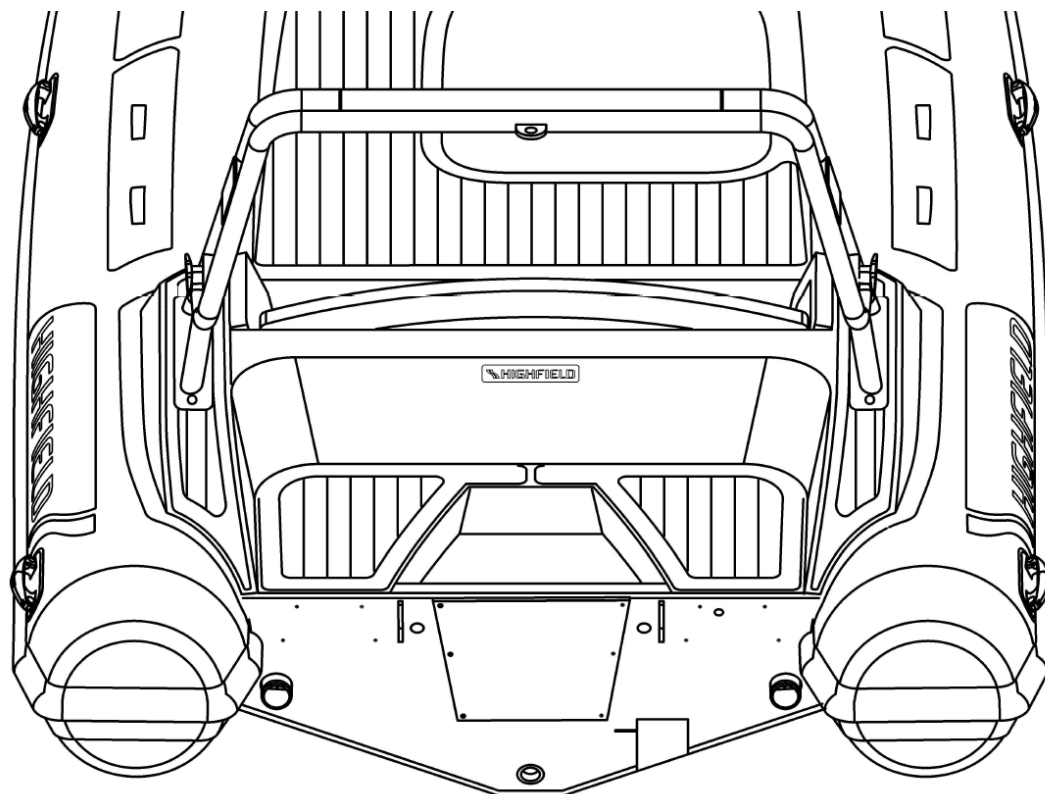

Congratulations, you have successfully installed the rollbar.