

Highfield Boats

Rear Tow Post Installation Guide (SP520-560)

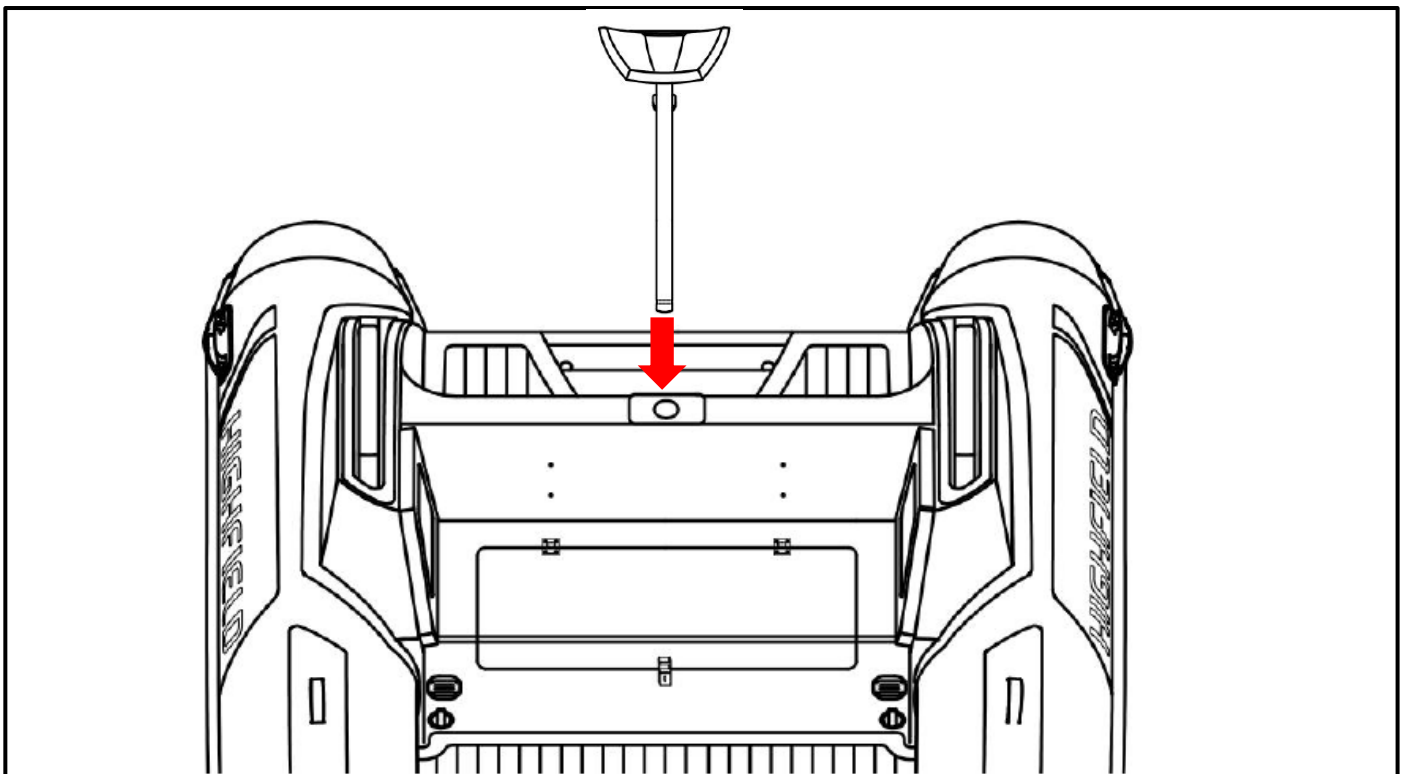

① Insert rear tow post through the installation opening on transom.

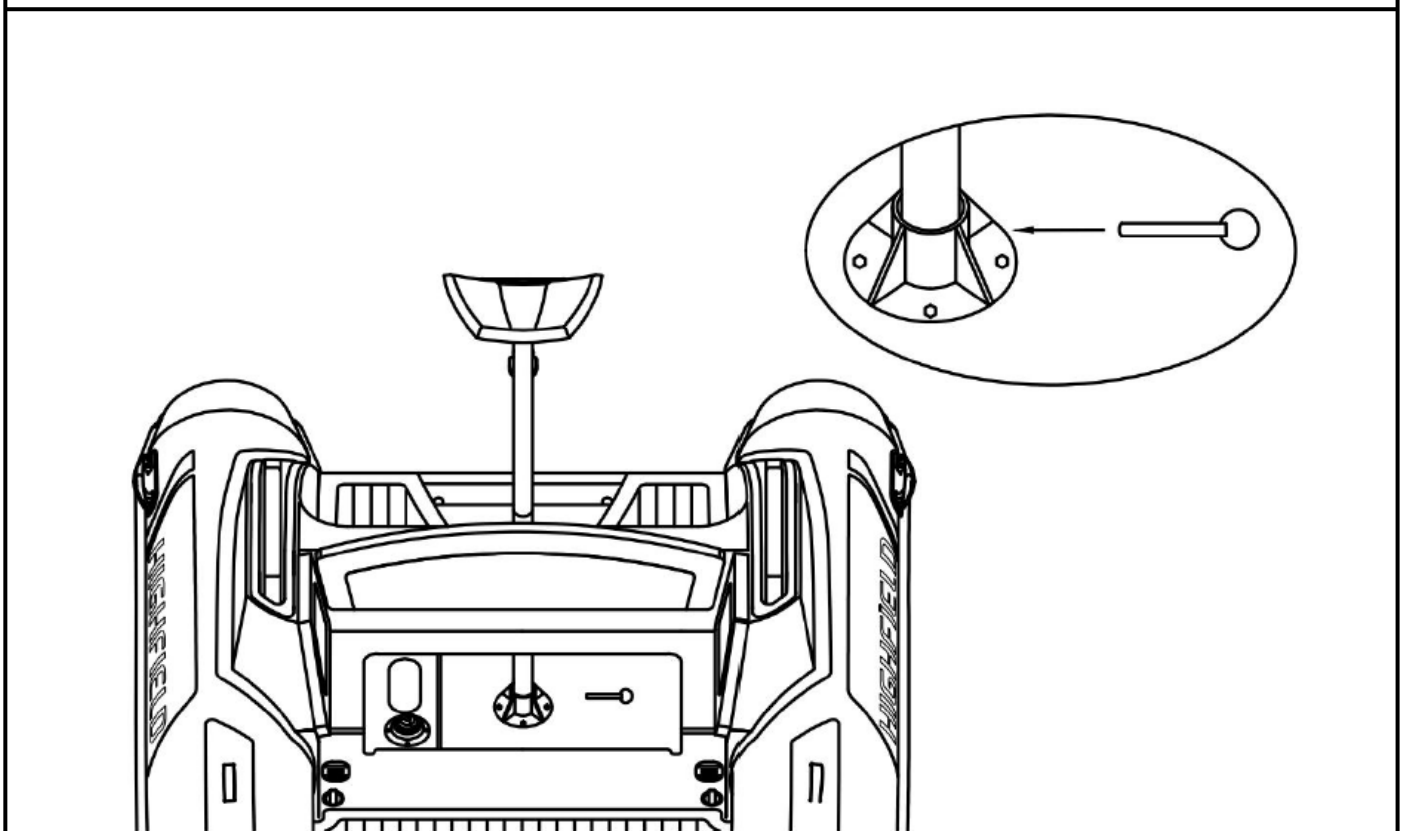

② Insert the pin into the installation hole to lock and fix the rear tow post.

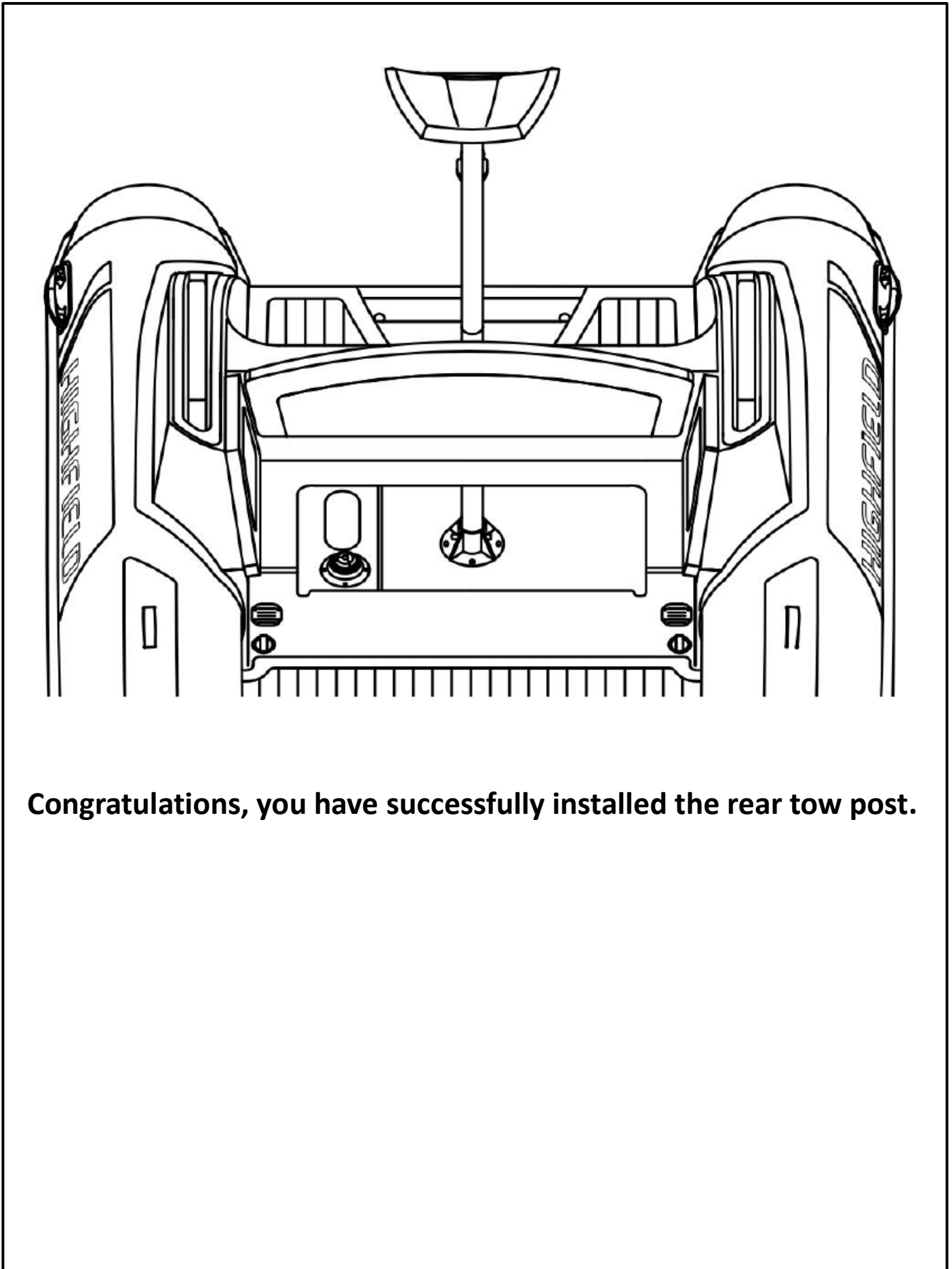

Congratulations, you have successfully installed the rear tow post.