

# Highfield Boats

## Driver's Seat Installation Guide (SP800)

# Installation Guide

(Driver's Seat: SPS800)

## Caution

Before installing consoles or seats over fuel tank access compartments, please remove the cover and check that all fuel fitting are secure. Please also check that electrical wiring and fuel lines are clear of the soon to be drilled cable access hole.

When tank cover is reinstalled use a silicone sealer on the lid.

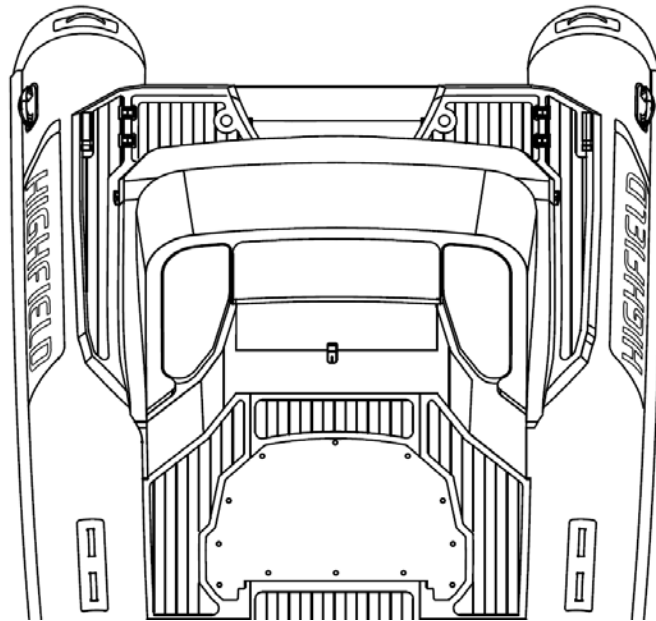
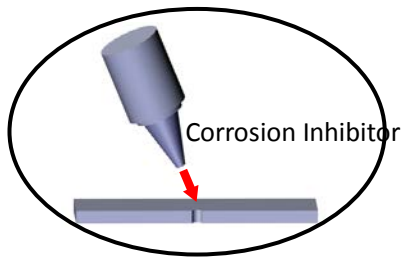

① Use insulating compound to eliminate corrosion between the aluminum and the stainless steel screws.

Recommended corrosion inhibitor: Duralac, Tef-Gel, Lanocote

polyurethane marine grade adhesive

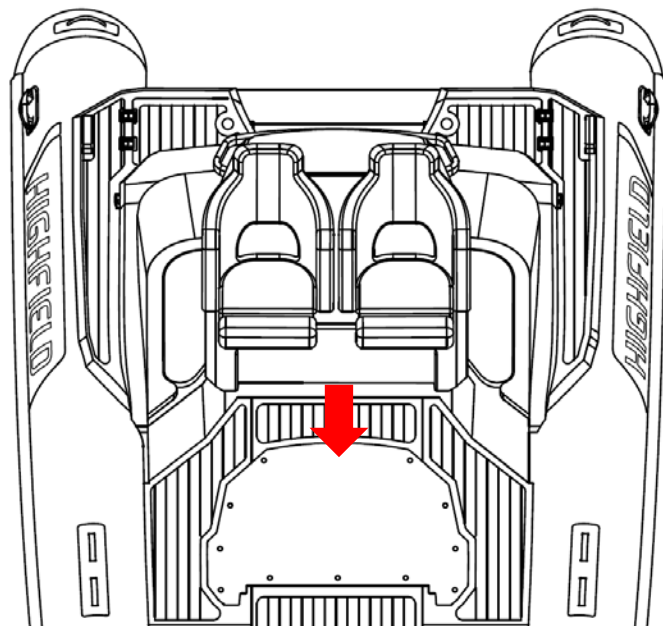
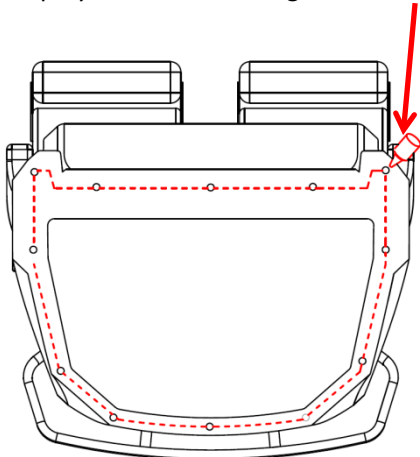

② Gently clean the deck. Secure the seat using polyurethane marine grade adhesive such as 3M 5200, Sika 291, Fixtech Fix 15.

# Installation Guide

(Driver's Seat: SPS800)

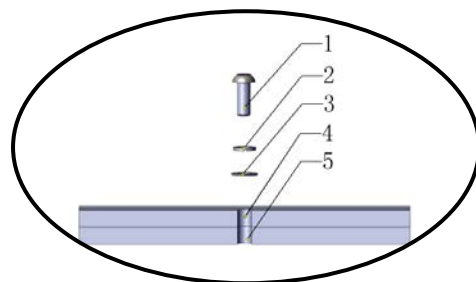
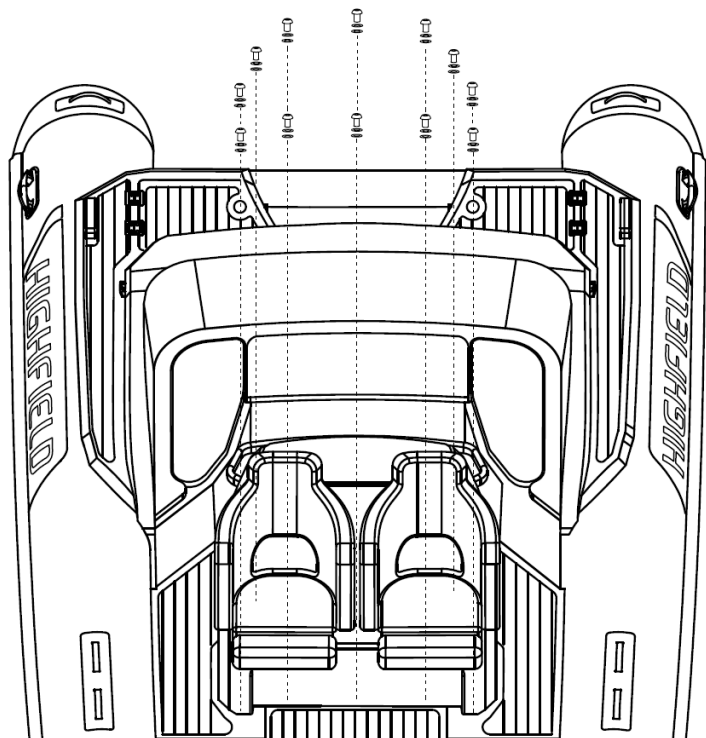

- 1—Screw M8×25mm;
- 2—Stainless steel spring washer M8×13mm
- 3—Stainless steel flat washer M8×24mm
- 4—Seat base;
- 5—Deck

③ Use insulating compound on the M8 stainless steel screws supplied with the seat. Fasten the seat to the deck using the screws.

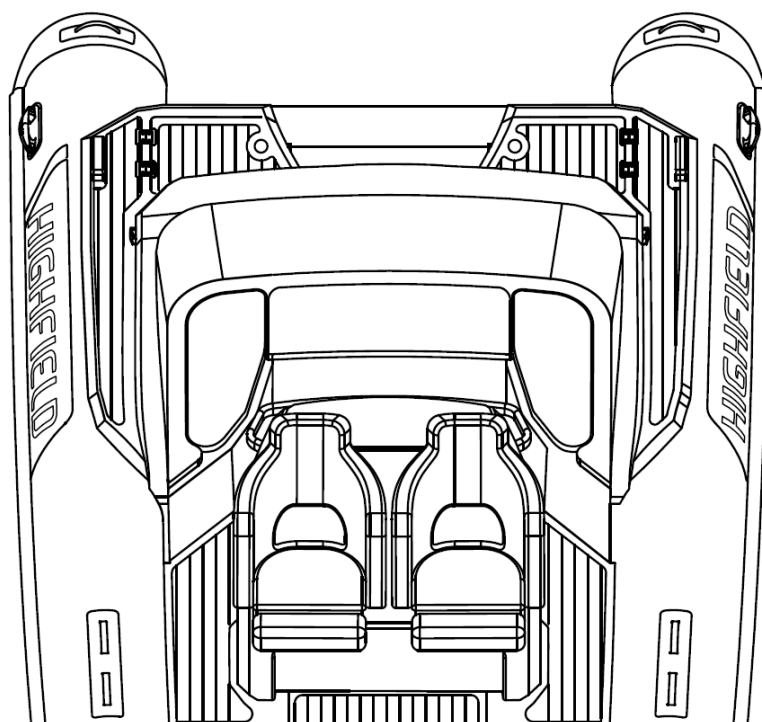

**Congratulations, you have successfully installed the driver's seat.**